

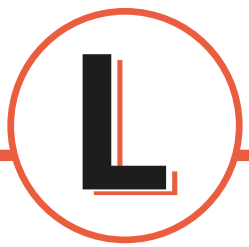

OlenBox series



olenergies



ULTRA COMPACT



LIGHT WEIGHT



LONG LIFE



NO MAINTENANCE



USABLE IN ALL DIRECTIONS



INFINITE PARALLEL ASSEMBLY

FICHE TECHNIQUE DATASHEET

LITHIUM-ION

48

Voltage

25

Capacity

1.25

kWh

ULTRA SECURE

LiFePO₄

100% ECO

FABRIQUÉ EN FRANCE



DIMENSIONS / DIMENSIONS

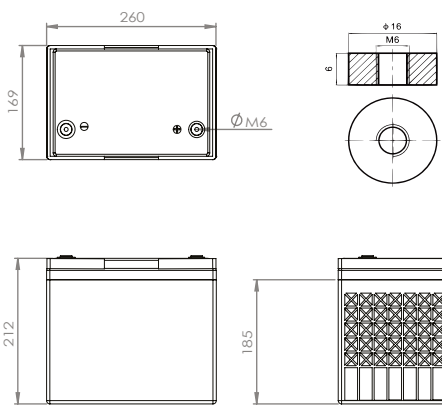

CARACTÉRISTIQUES / SPECIFICATIONS

Électrique <i>Electrical</i>	Tension nominale <i>Rated voltage</i>	52,0 V
	Capacité nominale <i>Rated capacity</i>	24,0 Ah
	Énergie <i>Energy</i>	1,25 kWh
	Résistance interne <i>Internal resistance</i>	≤ 54 mΩ
	Auto décharge mensuel <i>Monthly self discharge</i>	< 3 %
Charge <i>Charge</i>	Rendement de charge <i>Charge efficiency</i>	> 99 % @0,5C
	Tension de charge <i>Charge voltage</i>	58 ± 0,1 V
	Mode de charge <i>Charge mode</i>	CC/CV - Constant Current / Constant Voltage
	Courant de charge nominal <i>Rated charge current</i>	15,0 A
	Courant de fin de charge <i>Cut-off charge current</i>	0,05C
	Chargeurs et alternateurs <i>Chargers and alternators</i>	Compatible équipements plomb-acide <i>Compatible with Lead-Acid equipments</i>
Décharge <i>Discharge</i>	Rendement de décharge <i>Discharge efficiency</i>	> 98% @1C
	Courant de décharge continu <i>Continuous discharge current</i>	25 A
	Courant maximum 10 sec. <i>Maximum current 10 sec.</i>	200A
	Tension minimale <i>Discharge cut-off voltage</i>	40,0 V
Environnement <i>Environment</i>	Température de charge <i>Charge temperature</i>	0 °C à 45 °C
	Température de décharge <i>Discharge temperature</i>	-20 °C à 65 °C
	Température de stockage <i>Storage temperature</i>	0 °C à 40 °C
	Indice de protection <i>Ingress protection code</i>	IP65
Mécanique <i>Mechanical</i>	Matériau du boîtier <i>Case material</i>	ABS
	Dimensions (L*P*H) <i>Sizes (W*D*H)</i>	260*169*212 mm
	Masse <i>Weight</i>	10,4 kg
	Terminaux <i>Terminals</i>	M6 (laiton) M6 (brass)
Déploiement <i>Deployment</i>	Communications optionnelles <i>Communication protocols</i>	Bluetooth, CAN, Afficheur SoC, etc. avec SBM
	Garantie incluse et extension <i>Warranty included and extension</i>	2 ans et jusqu'à 10 ans avec OlenPeps 2 years and up to 10 years with Olenpeps

USAGES / APPLICATIONS



Stationnaire / Stationnary

Énergies renouvelables / *Renewable energies*,
Autoconsommation / *Home storage*



Mobile / Mobility

Naval / *Marine*, Véhicules de loisir / *RV-Buggy*,
Robots / *Robots*, Chariots élévateurs / *Forklifts*



Alimentation critique / Critical power supply

Onduleur / *Inverter*, ASI / *UPS*,
Centre de données / *Datacenter*

NOMBRE DE CYCLES / CYCLE LIFE

- ✓ 4000 cycles @80% DoD @80% SoH
- ✓ 8000 cycles @70% DoD @70% SoH
- ✓ 12000 cycles @60% DoD @80% SoH



PAS DE MISE EN SÉRIE POUR UN SYSTÈME DE 24 OU 48V
NO SERIAL ASSEMBLY FOR A 24 OR 48V SYSTEM



USER MANUAL



BMS
INSIDE



Lead-Acid
Plug-&-Play



Charge: 15A
0°C - 65°C



Discharge: 25A
-20°C - 65°C



Rated values:
52.0V | 24.0Ah



CELLS CONFORM
TO UL STD 1642



Li-ion



RoHS



CE



RECYCLING

COURBES / CURVES



SAFE
CLEAN
SMART

- ✓ 4.000 cycles @80% DoD
- ✓ 8.000 cycles @70% DoD
- ✓ 12.000 cycles @60% DoD



Durée de vie / Life Cycle

Une durée de vie jusqu'à 20 ans
Life cycle up to 20 years



Éco responsable / Eco-friendly

Pas de plomb ni cobalt : aucun élément dangereux
Neither lead-acid nor cobalt: no dangerous elements



100% sécurisé / 100% safe

Aucun risque d'incendie ou d'explosion
No risk of fire or explosion



Intelligence embarquée / Onboard intelligence

Notre BMS intelligent détecte toute anomalie
Our intelligent BMS detects any issue



Charge rapide / Fast charge

Charge rapide possible y compris de 80 à 100%
Fast charge possible including from 80 to 100%



De -20°C à +65°C / From -20°C to +65°C

Utilisable dans les environnements les plus sévères
Usable in the toughest environments

COURBES DE DURÉE DE VIE / LIFETIME CURVES

État de santé (SoH) en fonction du nombre de cycles pour différentes profondeurs de décharge (DoD) @1C et 25°C

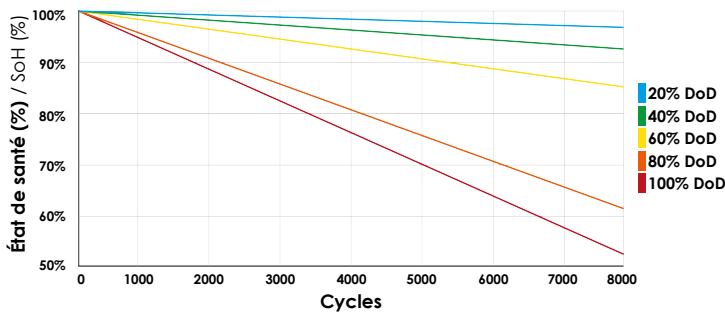

État de santé (SoH) en fonction du nombre de cycles pour différentes températures @1C et 100% DoD

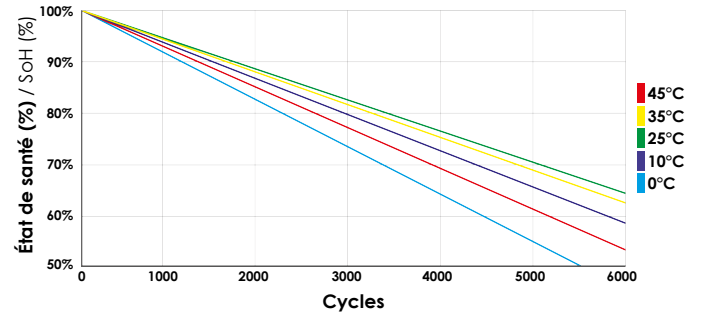

COURBES DE DÉCHARGE / DISCHARGE CURVES

Courbes de tension @25°C pour différents courants de décharge

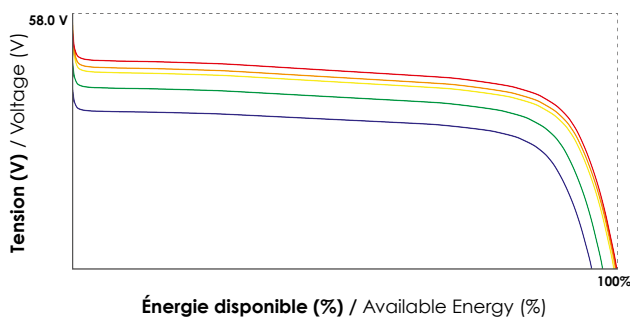

Courbes de tension @C/5 pour différentes températures

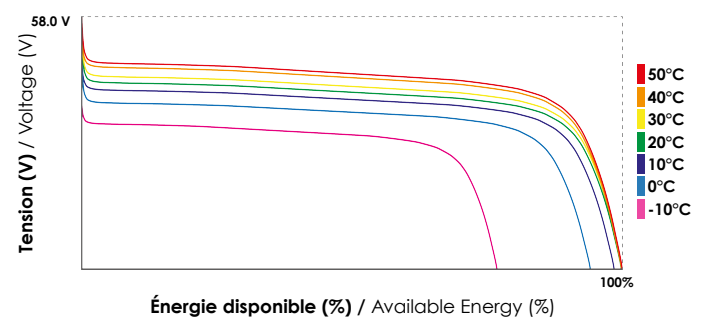

COURBE DE CHARGE / CHARGE CURVE

Profil de charge CCCV / recommandé

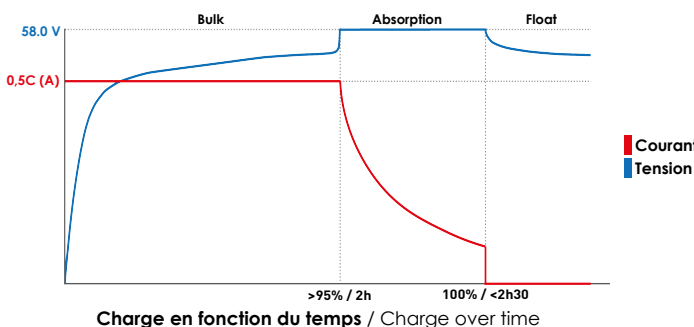

COURBE D'AUTO-DÉCHARGE / SELF-DISCHARGE

Auto-décharge en fonction du temps et température de stockage

